

TOP PLATE

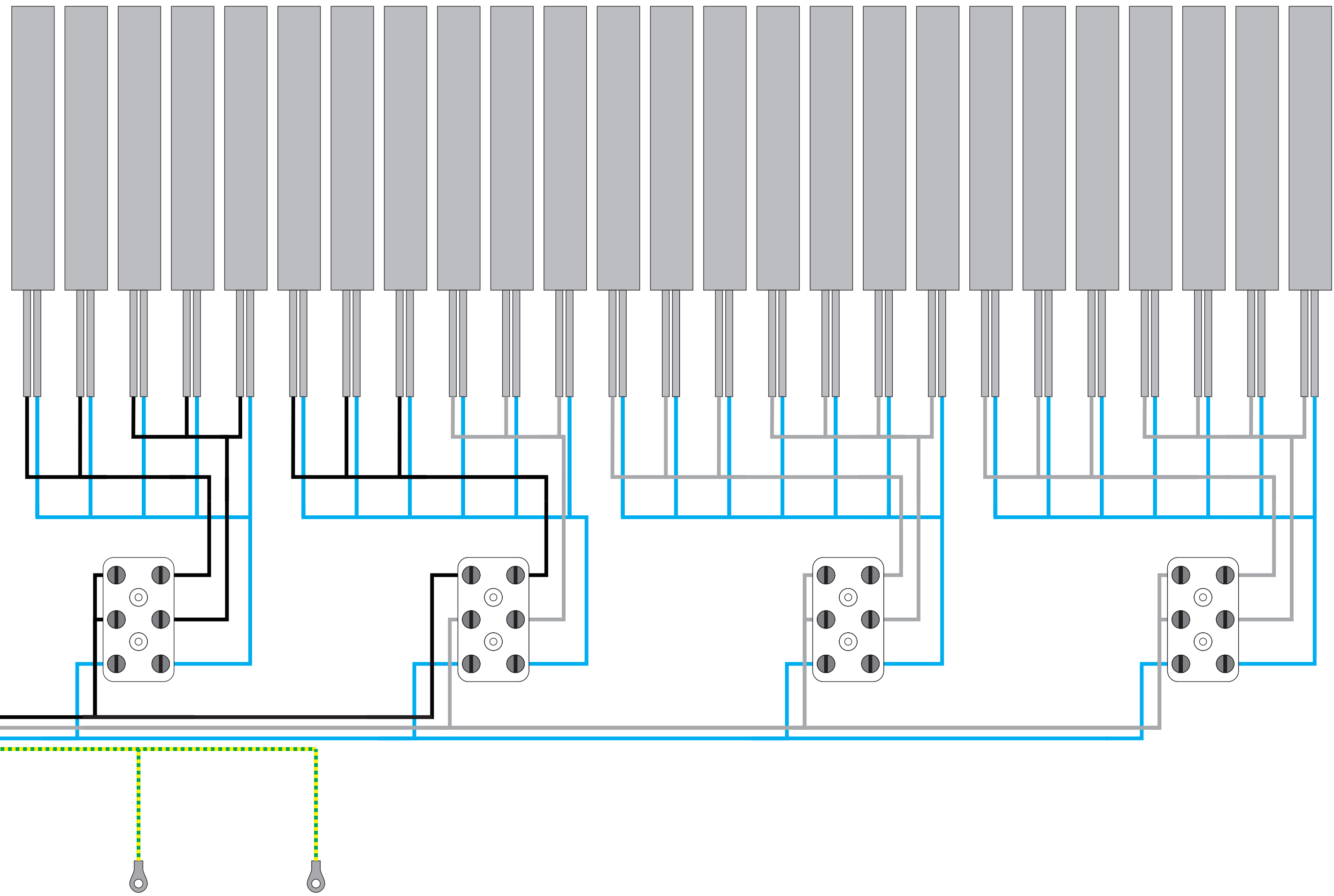

BOTTOM PLATE

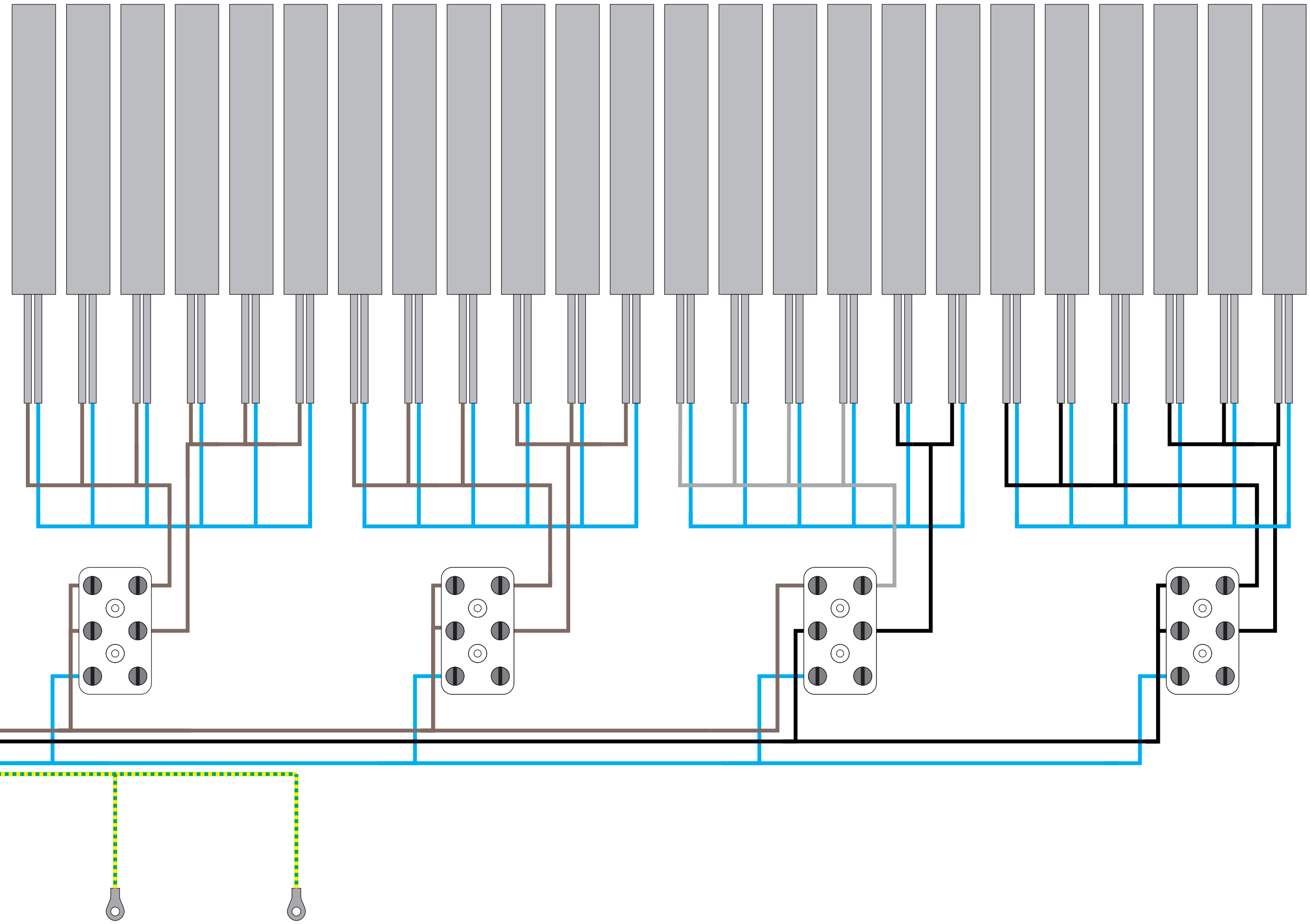

FRONT PANEL

BACK PANEL

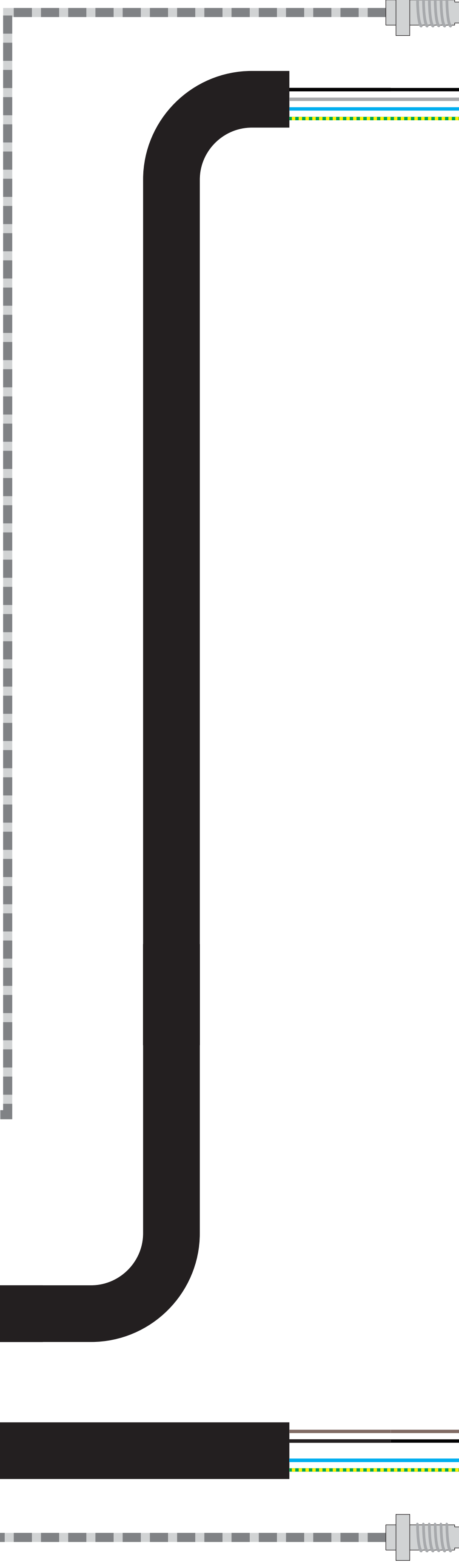
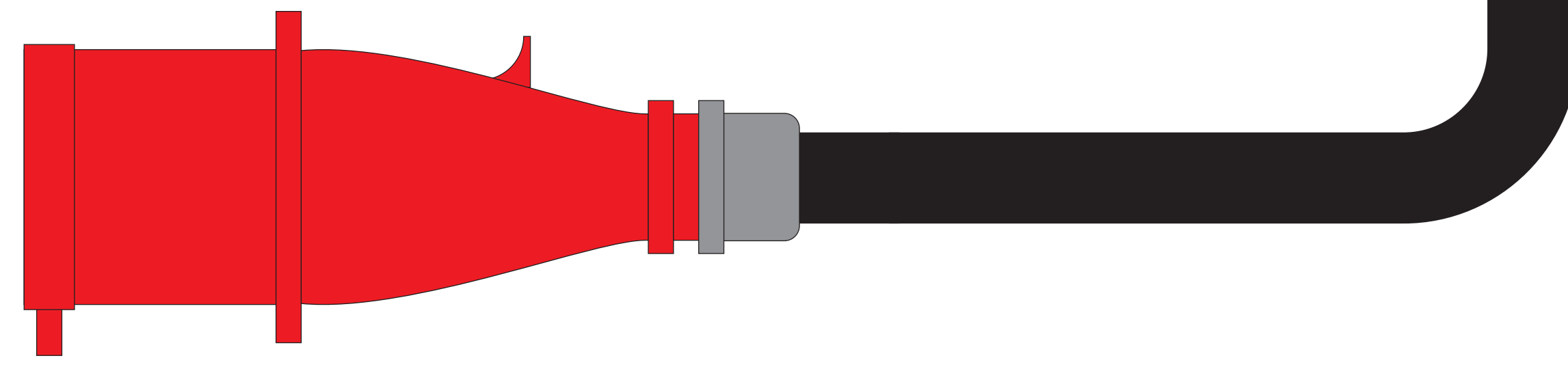
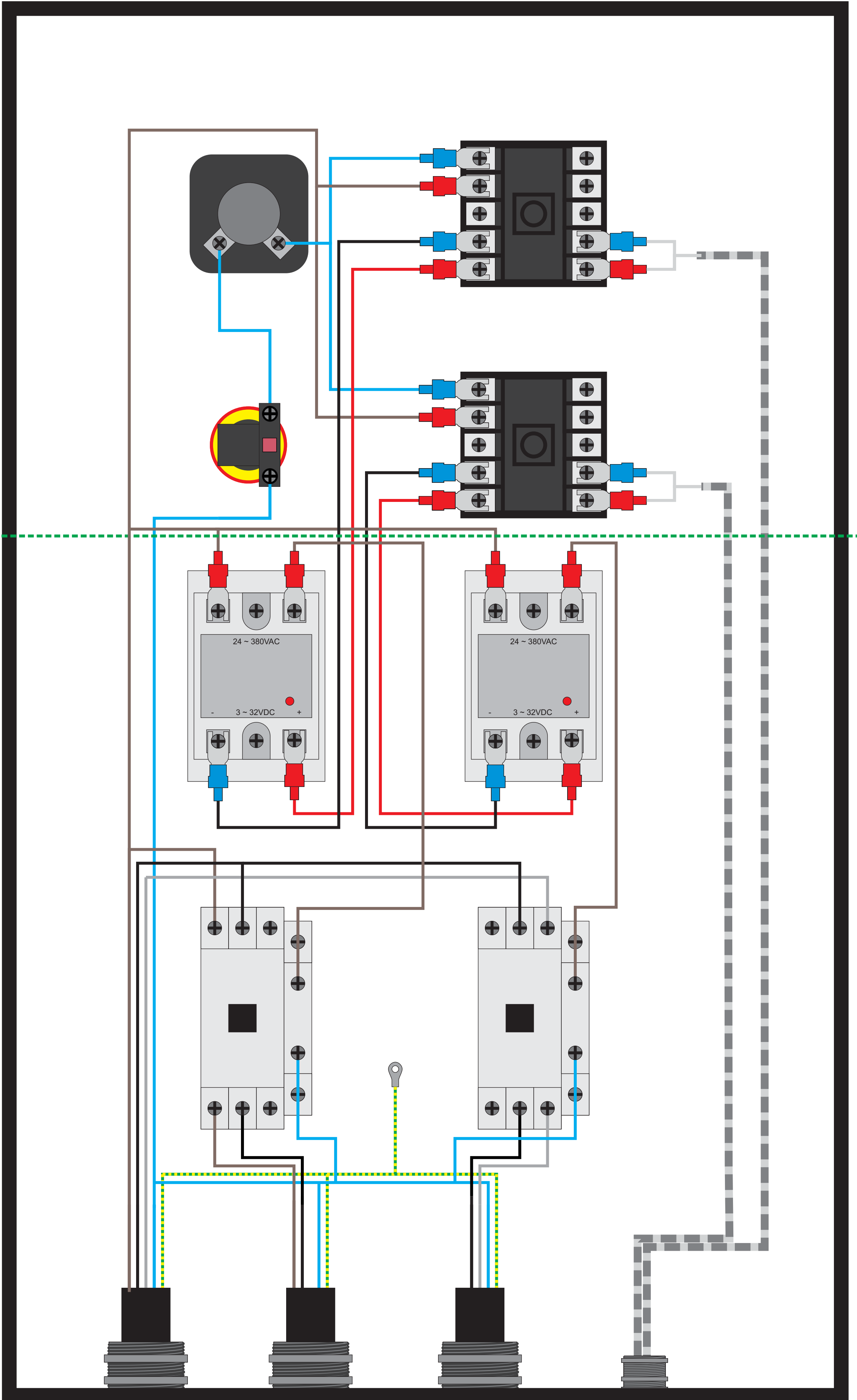

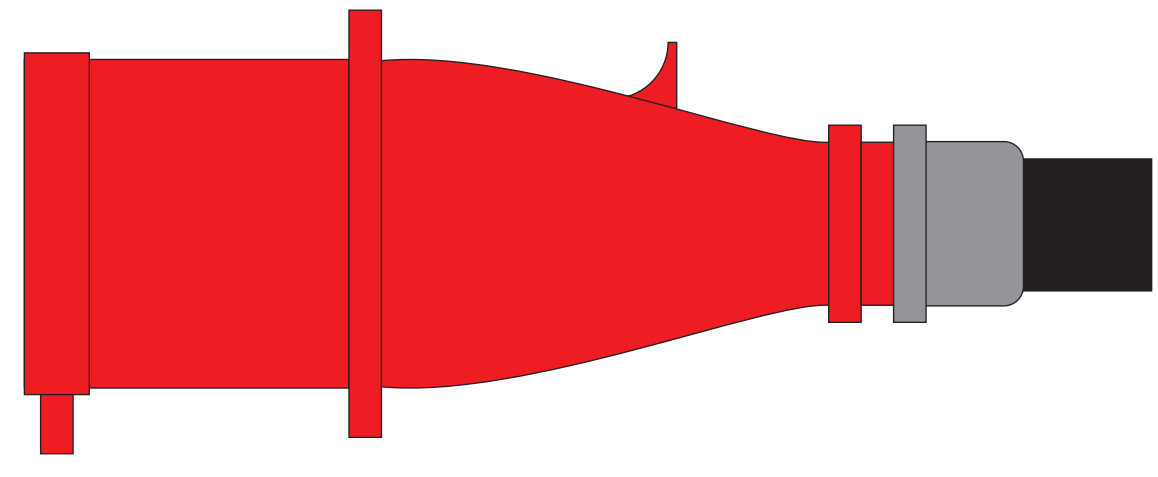

32A MALE PLUG

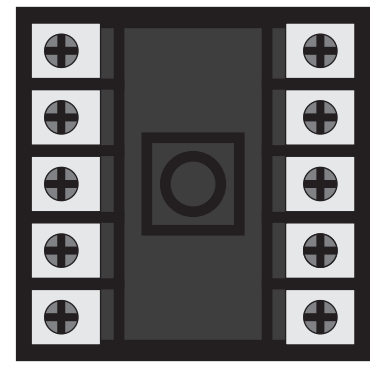

PID CONTROLLER

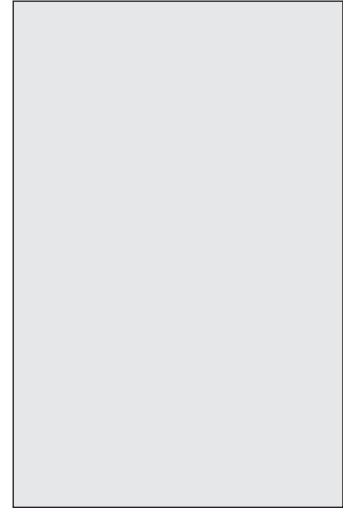

SSR HEAT SINK

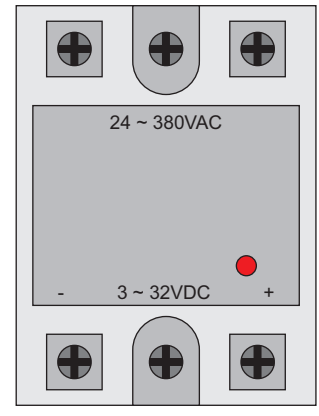

SSR 40A

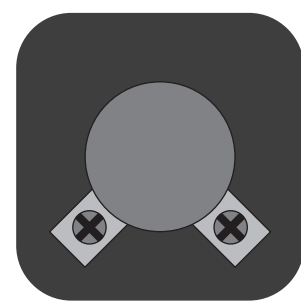

ROTARY SWITCH

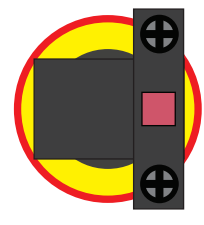

EMERGENCY STOP

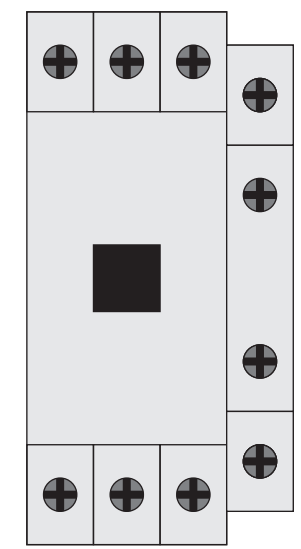

32A CIRCUIT
BREAKER RELAY



300W CARTRIDGE HEATER

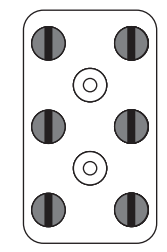

CERAMIC TERMINAL



K TYPE THERMOCOUPLE

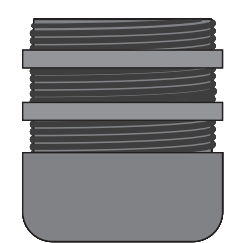

M20 CABLE GLAND

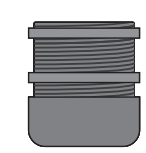

M10 CABLE GLAND

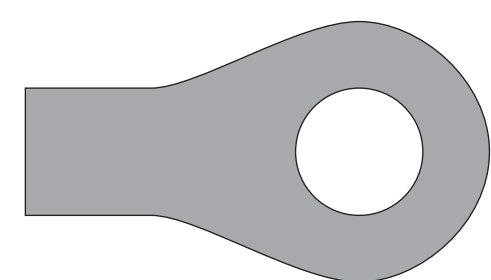

GROUND SPADE



16A 5 MULTI-CORE CABLE

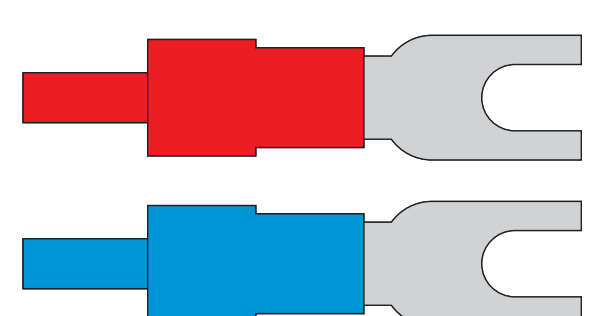

SPADE